

SHIMANO STOPS

SHIMANO Total Electric Power System

EP8

User's manual

Original instructions

CONTENTS

IMPORTANT NOTICE	2
Important safety information	2
NOTICE	3
Regular inspections before riding the bicycle	5
Booklet Structure	6
SHIMANO STEPS characteristics	7
Assist mode and customization.....	7
Customization of the riding comfort	8
Preparation	8
Quick guide	9
Making walking and pushing the bicycle easy (walk assist)	12
Automatic and manual gear shifting	14
Names of parts.....	15
Specifications.....	17
Troubleshooting	18
Assist function.....	18
Lights	19
Other.....	19

IMPORTANT NOTICE

- Contact the place of purchase or a distributor for information on installation, adjustment, and replacement of the products which are not found in the user's manual. A dealer's manual for professional and experienced bicycle mechanics is available on our website (<https://si.shimano.com>).
- Use the product according to local laws and regulations.
- The Bluetooth® word mark and logos are registered trademarks owned by Bluetooth SIG, Inc. and any use of such marks by SHIMANO INC. is under license. Other trademarks and trade names are those of their respective owners.

For safety, be sure to read this "user's manual" thoroughly before use, follow it for correct use, and store it so that it can be referenced at any time.

The following instructions must be observed at all times in order to prevent personal injury and physical damage to equipment and surroundings. The instructions are classified according to the degree of danger or damage which may occur if the product is used incorrectly.

DANGER

Failure to follow the instructions will result in death or serious injury.

WARNING

Failure to follow the instructions could result in death or serious injury.

CAUTION

Failure to follow the instructions could cause personal injury or physical damage to equipment and surroundings.

Important safety information

DANGER

Handling the battery

- Do not deform, modify, disassemble or apply solder directly to the battery. Doing so may cause leakage, overheating, bursting, or ignition of the battery.
- Do not leave the battery near sources of heat such as heaters. Doing so may cause bursting or ignition of the battery.
- Do not heat the battery or throw it into a fire. Doing so

may cause bursting or ignition of the battery.

- Do not subject the battery to strong shocks or throw it. If this is not observed, overheating, bursting, or fire may occur.
- Do not place the battery into fresh water or sea water, and do not allow the battery terminals to get wet. Doing so may cause overheating, bursting, or ignition of the battery.
- Use the SHIMANO specified charger and observe the specified charging conditions when charging the specified battery. Not doing so may cause overheating, bursting, or ignition of the battery.

WARNING

- Do not disassemble or modify the product. This may cause the product to not operate correctly, and you may suddenly fall and be seriously injured.

Riding precautions

- Do not to pay excessive attention to the cycle computer display while riding. Doing so can cause an accident such as a fall.
- Check that the wheels are securely installed to the bicycle before commencing riding. If the wheels are not securely installed, the bicycle may fall over and cause serious injury.
- If riding a power-assisted bicycle, make sure that you are fully familiar with the starting-off characteristics of the bicycle before riding it on roads with several vehicle lanes and pedestrian footpaths. If the bicycle starts off suddenly, accidents may result.
- Confirm that the light works before riding.

Safety precautions

- Be sure to remove the battery and charging cable before wiring or attaching parts to the bicycle. Failure to do so may cause an electric shock.
- When charging the battery while it is installed on the bicycle, do not move the bicycle. The power plug for the battery charger may come loose and not be fully inserted into the electrical outlet, resulting in risk of fire.
- Do not touch the drive unit when it has been continuously used for a long period of time. The surface of the drive unit becomes hot and could cause burns.
- Periodically clean the chain using an appropriate chain cleaner. The frequency of maintenance will vary depending on the riding conditions.

- Do not use alkaline or acidic cleaning agents for removing rust under any circumstances. If such cleaning agents are used, they may damage the chain and serious injury may result.
- Be sure to follow the instructions provided in the manuals when installing the product. It is recommended that you use SHIMANO genuine parts. Loose nuts or bolts and product damage may cause a sudden accident such as a fall and lead to serious injury.

Handling the battery

- If any liquid leaking from the battery gets into your eyes, immediately wash the affected area thoroughly with clean water such as tap water without rubbing your eyes, and seek medical advice immediately. If this is not done, the battery liquid may damage your eyes.
- Do not recharge the battery in places with high humidity or outdoors. Doing so may result in electric shock.
- Do not insert or remove the plug while it is wet. If this is not observed, electric shocks may result. If there is water leaking out of the plug, dry it thoroughly before inserting it.
- If the battery does not become fully charged even 2 hours after the designated charging time, immediately unplug the battery from the outlet and contact the place of purchase. Doing otherwise may cause overheating, bursting, or ignition of the battery. Refer to the battery charger user's manual for the designated charging time of the battery.
- Do not use the battery if it has any noticeable scratches or other external damage. Doing so may cause bursting, overheating or problems with operation.
- The operating temperature ranges for the battery are given below. Do not use the battery in temperatures outside these ranges. If the battery is used or stored in temperatures outside these ranges, fire, injury or problems with operation may occur.
 1. During discharge: -10°C - 50°C
 2. During charging: 0°C - 40°C



Riding precautions

- Observe the instructions in the user's manual for the bicycle, in order to ride safely.

Safety precautions

- Never modify the system. Doing so may cause a system error.

- Periodically check the battery charger and adapter, particularly the cord, plug, and case, for any damage. If the charger or adapter is broken, do not use it until it has been repaired.
- Use the product under the supervision of someone responsible for safety, and only as instructed. Do not allow anyone (including children) with reduced physical, sensual, or mental capacity, or those without experience or knowledge, to use the product.
- Do not allow children to play near the product.

Handling the battery

- Do not leave the battery in a place exposed to direct sunlight, inside a vehicle on a hot day, or other hot places. This may result in battery leakage.
- If any leaked fluid gets on your skin or clothes, wash it off immediately with clean water. The leaked fluid may damage your skin.
- Keep away from children.

NOTICE

Safety precautions

- If any malfunctions or other problems occur, contact the place of purchase.
- Be sure to attach dummy plugs to any unused E-TUBE ports.
- For installation and adjustment of the product, consult a dealer.
- The Product is designed to be fully waterproof to withstand wet weather riding conditions. However, do not deliberately place them into water.
- Do not clean the bicycle in a high-pressure wash. If water gets into any of the components, operating problems or rusting may result.
- Do not turn the bicycle upside down. There is a risk of damage to the cycle computer and switch unit.
- Handle the product carefully, and avoid subjecting it to any strong shocks.
- Although the bicycle still functions as a normal bicycle even when the battery is removed, the light does not turn on if it is connected to the electric power system. Be aware that using the bicycle under these conditions will be considered non-observance of the road traffic laws in Germany.

- When charging the battery while it is mounted on the bicycle, be careful of the following:
 - When charging, make sure there is no water on the charging port or the charger plug.
 - Ensure that the battery is locked into the battery mount before charging.
 - Do not remove the battery from the battery mount while charging.
 - Do not ride with the charger mounted.
 - Close the charging port cap when not charging.
 - Stabilize the bicycle to ensure that it does not collapse during charging.

Handling the battery

- When you carry a power-assisted bicycle in a car, remove the battery from the bicycle and place the bicycle on a stable surface in the car.
- Before connecting the battery, make sure that there is no water collecting in the area where the battery will be connected (connector), and that it is not dirty.
- The use of a SHIMANO genuine battery is recommended. If using a battery from another manufacturer, make sure to carefully read the manual thoroughly before use.

About used batteries

Disposal information for countries outside the European Union



This symbol is only valid within the European Union. Follow local regulations when disposing of used batteries. If you are not sure, consult the place of purchase or a bicycle dealer.

Connection and communication with PC

A PC linkage device can be used to connect a PC to the bicycle (system or components), and E-TUBE PROJECT can be used to carry out tasks such as customizing single components or the whole system and updating firmware.

- PC linkage device: SM-PCE1/SM-PCE02
- E-TUBE PROJECT: PC application
- Firmware: software inside each component

Connection and communication with smartphone or tablet

It is possible to customize single components or the system, and update firmware, using E-TUBE PROJECT for smartphones/tablets after connecting the bicycle (system or components) to a smartphone or tablet via Bluetooth® LE.

- E-TUBE PROJECT: app for smartphones/tablets
- Firmware: software inside each component

Care and maintenance

- The number found on the battery mount key is necessary when purchasing spare keys. Keep it in a safe place.
- Contact the place of purchase for updates of the product software. The most up-to-date information is available on the SHIMANO website. For details, refer to the "Connection and communication with devices." section.
- Do not use thinner or other solvents to clean any of the products. As such substances may damage the surfaces.
- You should periodically wash the chainrings in a neutral detergent. In addition, cleaning the chain with neutral detergent and lubricating it can be an effective way of extending the useful life of the chainrings and the chain.
- Use a damp cloth, with the water well wrung out, when cleaning the battery and plastic cover.
- For any questions regarding handling and maintenance, contact the place of purchase.
- Products are not guaranteed against natural wear and deterioration from normal use and aging.
- For maximum performance we highly recommend SHIMANO lubricants and maintenance products.

Assist

- If the settings are not correct, for instance if the chain tension is too tight, the proper assist force may not be obtained. If this happens, contact the place of purchase.

Label

- Some of the important information contained in this user's manual is also indicated on the battery charger label.

Regular inspections before riding the bicycle

Before riding the bicycle, check the following items. If any problems are found with the following items, contact the place of purchase or a distributor.

- Does the drive train perform gear shifting smoothly?
- Are the components fixed securely and free from damage?
- Are the components securely installed to the frame/handlebar/stem, etc.?
- Do any abnormal noises occur while riding?
- Is there sufficient charge remaining in the battery?

Please avoid wearing clothes that can get caught in the chain or wheel because it can lead to an accident.

FCC compliance information

This device complies with Part 15 of the FCC Rules.

Operation is subject to the following two conditions:

- (1) This device may not cause harmful interference, and
- (2) This device must accept any interference received, including interference that may cause undesired operation.

NOTICE: This equipment has been tested and found to comply with the limits for a Class B digital device, pursuant to Part 15 of the FCC Rules. These limits are designed to provide reasonable protection against harmful interference in a residential installation. This equipment generates, uses and can radiate radio frequency energy and, if not installed and used in accordance with the instructions, may cause harmful interference to radio communications. However, there is no guarantee that interference will not occur in a particular installation. If this equipment does cause harmful interference to radio or television reception, which can be determined by turning the equipment off and on, the user is encouraged to try to correct the interference by one or more of the following measures:

- Reorient or relocate the receiving antenna.
- Increase the separation between the equipment and receiver.
- Connect the equipment into an outlet on a circuit different from that to which the receiver is connected.
- Consult the dealer or an experienced radio/TV technician for help.

Booklet Structure

SHIMANO STEPS user's manuals are split among several booklets, as described below.

Be sure to read these user's manuals thoroughly before use, and follow them for correct use. Store the user's manuals so that they can be referenced at any time.

The latest user's manuals are available on our website (<https://si.shimano.com>).

- **SHIMANO STEPS user's manual (this document)**

This is the basic user's manual for SHIMANO STEPS. It contains the following content.

- SHIMANO STEPS quick guide
- How to operate assist bicycles that use flat handlebars, such as city, trekking, or MTB type bicycles
- Troubleshooting

- **SHIMANO STEPS user's manual for drop handlebar bicycles (separate booklet)**

This booklet describes how to operate assist bicycles that use a drop handlebar and are controlled using a dual control lever. This should be read along with the SHIMANO STEPS user's manual.

- **SHIMANO STEPS special battery and parts user's manual**

It contains the following content.

- How to charge and handle the SHIMANO STEPS special battery
- How to attach and remove the SHIMANO STEPS special battery to the bicycle
- How to use the satellite power button and satellite charging port
- How to read the battery LEDs when charging or during an error, and how to handle errors

- **SHIMANO STEPS cycle computer user's manual**

It contains details on the SHIMANO STEPS cycle computer. Refer to it for how to view the display and how to configure the settings.

- **Switch unit user's manual**

This is the assist switch and shifting switch user's manual. It describes switch unit operations.

SHIMANO STEPS characteristics

• Pursuing the likeness of a bicycle

The light compact design of the drive unit reduces the operation noise and makes pedaling lighter so that you don't feel the existence of a motor. Also, due to the shortening of the Q factor, the riding comfort has been improved and is more bicycle-like.

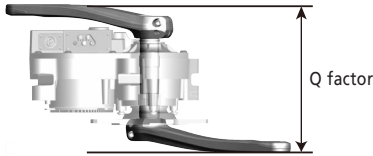

• Improved assist traveling range

Reduced electric consumption while obtaining enough assist. It supports various riding methods.

• Automatic gear shifting (for internal electronic 8/5 speed gear shifting)

The sensor detects riding conditions such as climbing a hill in headwinds or riding in windless flatland, and further improves riding via computer-controlled automatic gear shifting.







• Start mode (for internal electronic gear shifting)

This function automatically shifts down to the gear position that has been set in advance when stopped at a traffic light and allows you to start in a light gear.

* If you gear shift into a gear that is lower than the gear position set while the bicycle is stopped, the gear will not shift up automatically.

Assist mode and customization

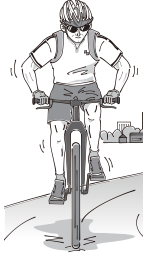
You can select an assist mode for each particular application. The assist modes that can be selected differ according to the assist bicycle.

[BOOST] / [HIGH]	[TRAIL] / [NORMAL] **	[ECO]
 	 	 
<ul style="list-style-type: none"> • Precipitous mountain roads • Sudden slopes 	<p>Gentle ascending slopes and level ground</p>	<ul style="list-style-type: none"> • Long distance riding on level ground • Level parks with signals
<p>When the battery level is running low, the level of assistance is lowered to increase the traveling range.</p>		
<p>[OFF]</p>		
<ul style="list-style-type: none"> • When you don't need power assistance. • When you are concerned about remaining battery power. 		

[WALK] *2

- When walking while pushing the bicycle across uneven terrain such as rocky areas.
- When walking while pushing a bicycle with heavy luggage on it.
- When climbing while pushing the bicycle up a hill such as a slope in an underground bicycle parking lot.

*1 Depending on the cycle computer, [NORM] is displayed.

*2 Depending on the region of use, you may not be able to select it due to the laws of the region.

■ Customization of the riding comfort

This function is for you to enjoy the assist bicycle as a sports bicycle. Multiple recommended settings regarding the output characteristics of assistance are prepared when you make a purchase and by switching from a compatible cycle computer, it can greatly affect the riding comfort even if it has the same assist mode.

Also, by connecting to E-TUBE PROJECT you can freely adjust the riding comfort more than before. Refer to the user's manual compatible with cycle computers.

Preparation

You cannot use the battery immediately after shipment.

The battery can be used after charging it with the designated charger.

Be sure to charge it before use. The battery can be used when the LED on it lights up.

Please read the SHIMANO STEPS special battery and parts user's manual for how to charge and handle the battery.

Quick guide

This section explains how to handle an assist bicycle that has had SHIMANO STEPS installed.



Depending on the assist bicycle used, the installed battery, cycle computer, and switch unit may differ from what is listed here. Please view the "SHIMANO STEPS special battery and parts user's manual" and the "SHIMANO STEPS cycle computer user's manual" as well.

1. Charge the battery.

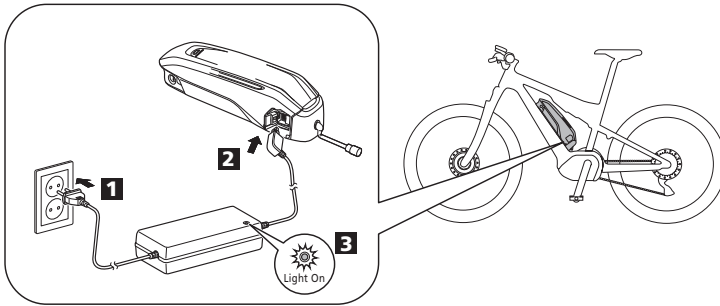

Example of external type battery

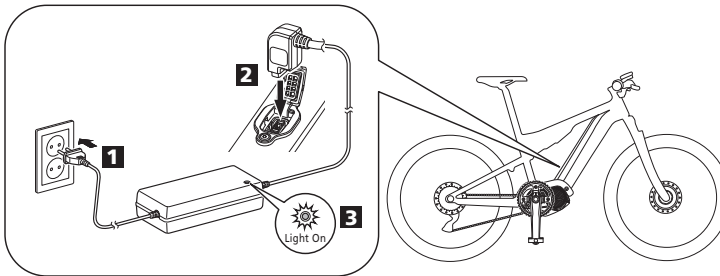

Example of built-in type battery

* According to the assist bicycle, the location of the charging port may be different from the one shown in the figure.



 Lights up	Charging
 Flashing	Charging error

2. Turn the power ON.

To turn OFF the power, repeat this procedure.

Example of external type battery

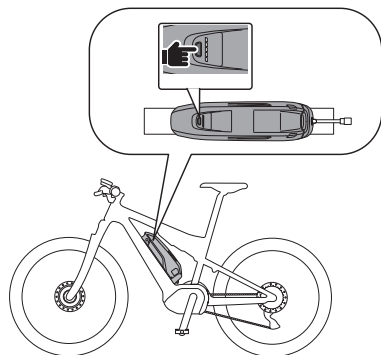

Example of built-in type battery

* According to the assist bicycle, the location of the power button may be different from the one shown in the figure.

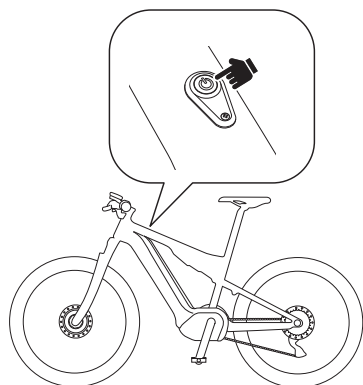

3. Select assist mode.

* If you turn the power ON, assist mode is reset to [OFF] regardless of the assist mode that you had selected before you last turned the power OFF.

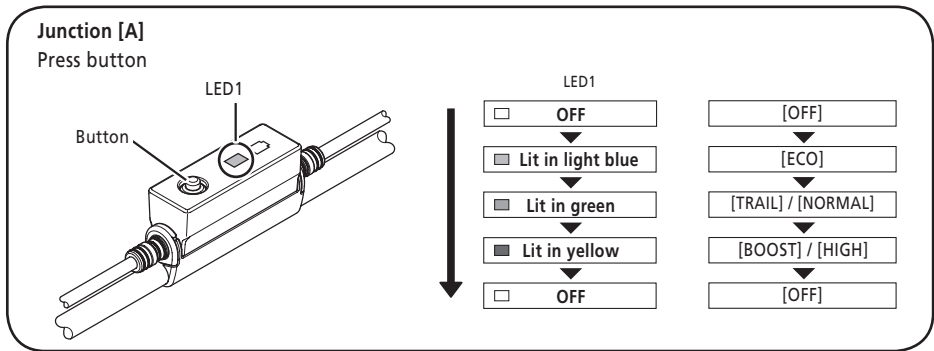
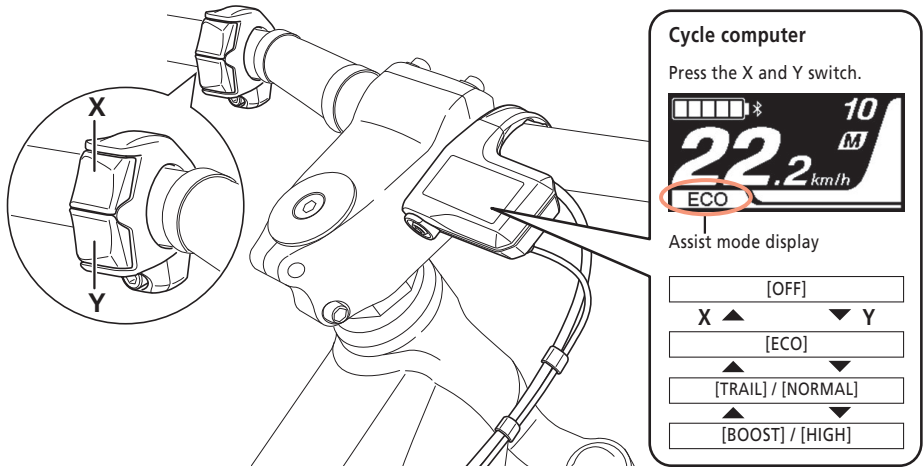

4. Get on the bicycle and start riding.

Assist will start when you start pedaling.



Be sure to learn the brake control characteristics and other characteristics. Brake handling may vary slightly depending on the bicycle you are using.

5. Turn the power OFF and park your bicycle when you arrive at your destination.

■ Making walking and pushing the bicycle easy (walk assist)

SHIMANO STEPS has a function where assist works even when you are walking and pushing the assist bicycle.

- Depending on the region of use, you may not be able to use it due to the laws of the region. In this case, the operations described here are disabled.
- This function cannot be used with bicycles that do not have assist switch installed.

1. Stop and switch to walk assist mode.

Hold down the button (Y button) on the lower side of the assist switch (left side of the handle) until it reaches the following state.

- Cycle computer: [WALK] is displayed
- Junction [A]: LED on the button side lights up in blue

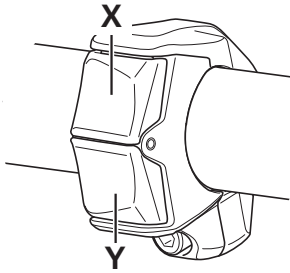

Example of cycle computer



Example of junction [A]



- If nothing is done for one minute after switching to walk assist mode, it will switch back to the assist mode that was selected before switching.

2. Push the bicycle carefully while pressing the same button again.

If you let go of the Y button, the assist stops.

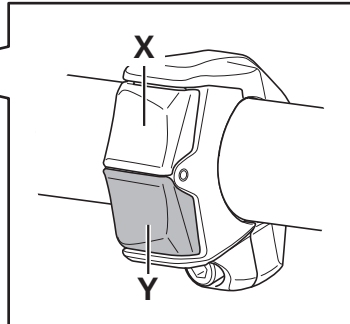

NOTICE

Walk assist operates at a maximum of 6 km/h. Be careful because the bicycle starts moving just by button operations.



- During electronic gear shifting, the assistance of walk assist and speed are controlled by the current gear position.

3. Exit walk assist mode.

Press the button (X button) on the upper side of the assist switch (left side of the handle).

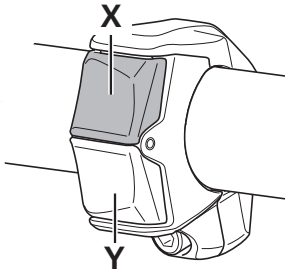

■ Automatic and manual gear shifting

Depending on the assist bicycle used, you may be able to switch between automatic and manual gear shifting.

- Automatic gear shifting: Automatically shifts gears based on the riding conditions.
- Manual gear shifting: This refers to standard electronic gear shifting. Gears are shifted by operating the shifting switch.

1. Switch between automatic and manual gear shifting.

The shifting switch (right side of the handle) is operated as follows, depending on the type.

Shifting changes from automatic to manual gear shifting and back again with each operation.

- 2-switch type shifting switch: Press the X and Y buttons together
- 3-switch type shifting switch: Press the A button

2-switch type
shifting switch example

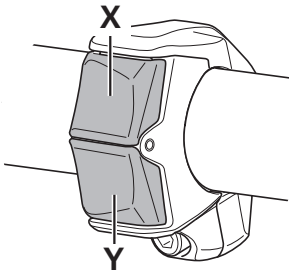

3-switch type
shifting switch example

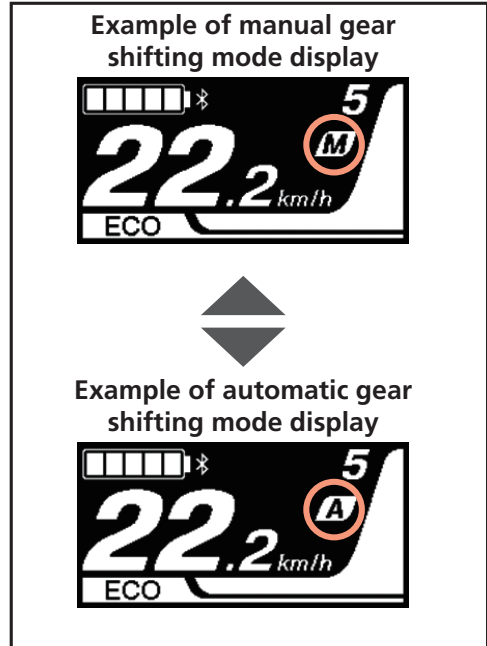
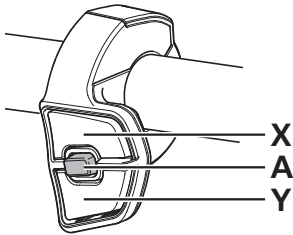

- Depending on the cycle computer, [Auto] is displayed when in automatic gear shifting mode, and [Manual] is displayed when in manual gear shifting mode.

Names of parts

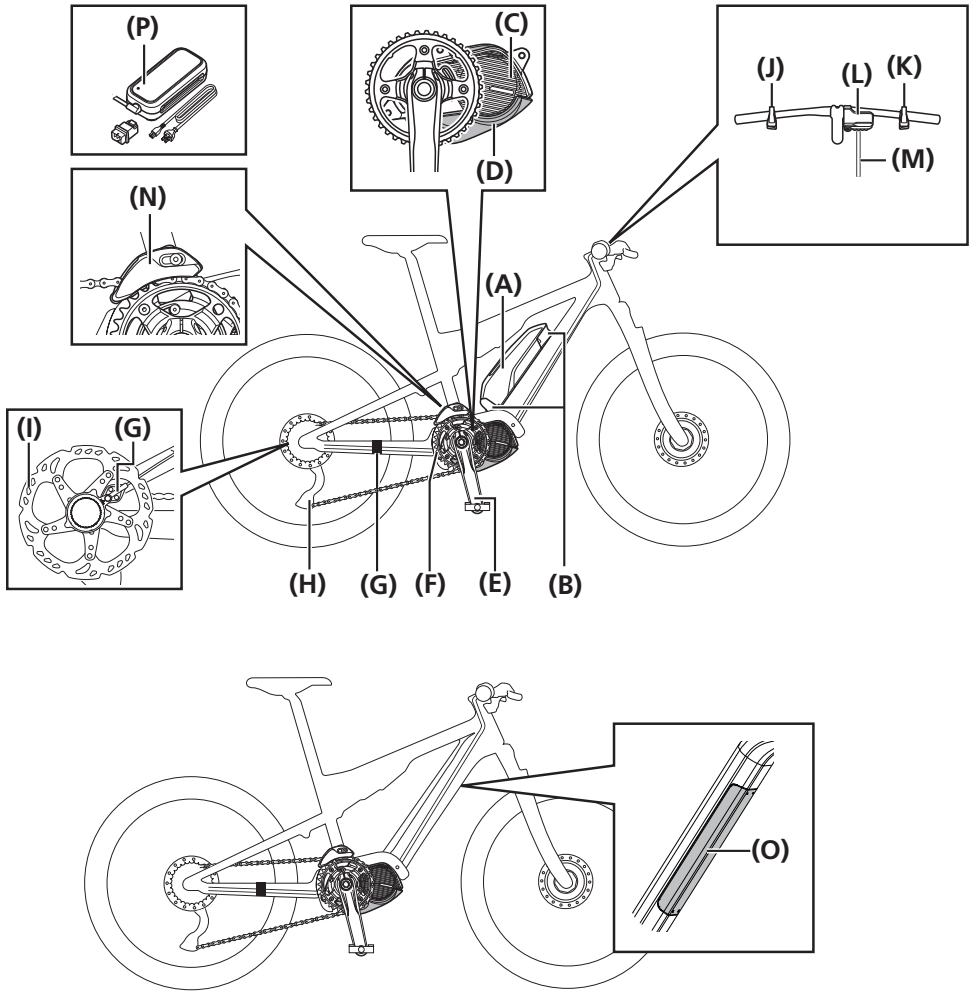

(A)	External type battery *1	(B)	Battery mount *2
(C)	Drive unit	(D)	Drive unit cover (left side and bottom side)
(E)	Crank arm	(F)	Chainring unit
(G)	Speed sensor *3	(H)	Shifting unit *4
(I)	Disc brake rotor	(J)	Switch unit (assist switch)
(K)	Switch unit (shifting switch) or shifting lever	(L)	Cycle computer or junction [A]
(M)	Electric wire	(N)	Chain device
(O)	Built-in type battery *1	(P)	Battery charger

*1 Depending on the assist bicycle, the battery may be installed at a location different from the position specified in the figure.

*2 The battery mount of the built-in type battery is attached inside the frame.

*3 It is attached to one of the two locations specified in the figure.

*4 Electronic gear shifting: DI2 rear derailleur or motor unit + DI2 internal geared hub
 Mechanical gear shifting: rear derailleur or internal geared hub

Specifications

Operating temperature range: During discharge	-10 - 50°C	Battery type	Lithium ion battery
Operating temperature range: During charging	0 - 40°C	Nominal capacity	Please read the SHIMANO STEPS special battery and parts user's manual.
Storage temperature	-20 - 70°C	Rated voltage	36 V DC
Storage temperature (Battery)	-20 - 60°C	Drive unit type	Midship
Charging voltage	100 - 240 V AC	Motor type	Brush-less DC
Charging time	Please read the SHIMANO STEPS special battery and parts user's manual.	Rated drive unit power	250 W

* The maximum speed that provides assist is set by the bicycle manufacturer, but may vary depending on the conditions under which the bicycle is used.

Troubleshooting

NOTICE

The following notifications will occur when a malfunction occurs with the assist bicycle.

- Beep sounds and error messages on the cycle computer
- Battery LED error indications

Perform the appropriate actions after viewing the "SHIMANO STEPS cycle computer user's manual" and the "SHIMANO STEPS special battery and parts user's manual".

■ Assist function

Symptom	Cause / Possibility	Remedy
Assistance is not being provided.	Is the battery sufficiently charged?	Check the battery level and if it is low, charge the battery.
	Are you riding on long slopes in summer weather or riding for a long time carrying a heavy load? The battery may be overheating.	Turn off the power, wait for a while and then check once more.
	The drive unit, cycle computer or assist switch may be connected incorrectly or there may be a problem with one or more of them.	Contact the place of purchase.
	Is the speed too high?	Check the Cycle Computer display. Assist will not occur if the speed is above the bicycle manufacturer's setting value.
	Are you pedaling?	The bicycle is not a motorbike, so you need to operate the pedals.
	Is the assist mode set to [OFF]?	Set assist mode to a mode other than [OFF]. If you still do not feel that assistance is being given, contact the place of purchase.
	Is the system power ON?	If you do not feel the assist after performing the following, contact the place of purchase. Press the power switch on the cycle computer or the battery power button to turn the power back ON.

Symptom	Cause / Possibility	Remedy
Assist traveling distance is too short.	The traveling distance may become shorter depending on road conditions, the gear position and total light usage time.	Check the battery charge. If the battery is nearly spent, recharge it.
	The battery characteristics will drop during winter weather.	This is not a sign of a problem.
	The battery is a consumable part. Repeated recharging and long periods of use will cause the battery to deteriorate (lose its performance).	If the distance that can be traveled on a single charge is very short, replace the battery with a new one.
	Is the battery fully charged?	If the distance that can be traveled when the battery is fully charged has decreased, the battery may have degraded. Replace the battery with a new one.
Pedaling is stiff.	Are the tires inflated to a sufficient pressure?	Inflate the tire with a bicycle pump.
	Is the assist mode set to [OFF]?	Set the assist mode to a mode other than [OFF]. If you still do not feel the assist, contact the place of purchase.
	The battery may be running low.	Check the assistance again after sufficiently charging the battery. If you still do not feel the assist, contact the place of purchase.

■ Lights

Symptom	Cause / Possibility	Remedy
The front light or the tail light does not illuminate even when the switch is pressed.	The E-TUBE PROJECT settings may be wrong.	Contact the place of purchase.

■ Other

Symptom	Cause / Possibility	Remedy
When using an electronic gear shifting, I feel that the level of assistance weakens when the gears shift.	This occurs because the level of assistance is being adjusted to the optimum level by computer.	It is not a sign of a malfunction.
Sound occurs after gear shifting.		Contact the place of purchase.
A noise can be heard from the rear wheel during normal riding.	Gear shifting adjustment may not have been carried out correctly.	Contact the place of purchase.

SHIMANO

SHIMANO NORTH AMERICA BICYCLE, INC.

One Holland, Irvine, California 92618, U.S.A. Phone: +1-949-951-5003

SHIMANO EUROPE B.V.

High Tech Campus 92, 5656 AG Eindhoven, The Netherlands Phone: +31-402-612222

SHIMANO INC.

3-77 Oimatsu-cho, Sakai-ku, Sakai City, Osaka 590-8577, Japan

Please note: specifications are subject to change for improvement without notice. (English)

© Feb. 2020 by SHIMANO INC. ITP